

FDL (AC: 100VAC)

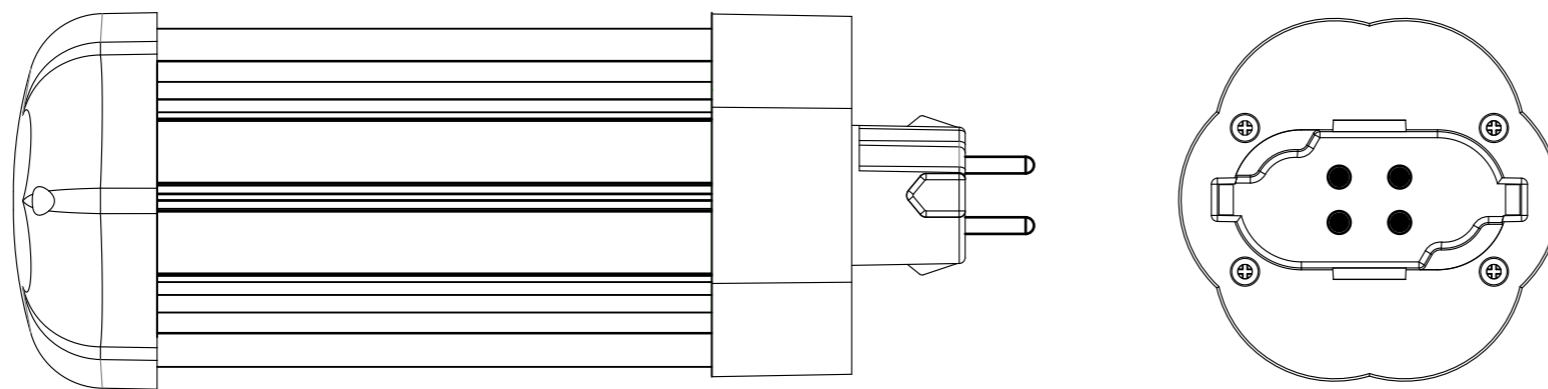

極性関係なく 4つのピン中、二つのピンにつなげれば点灯されます。

Installation: 1

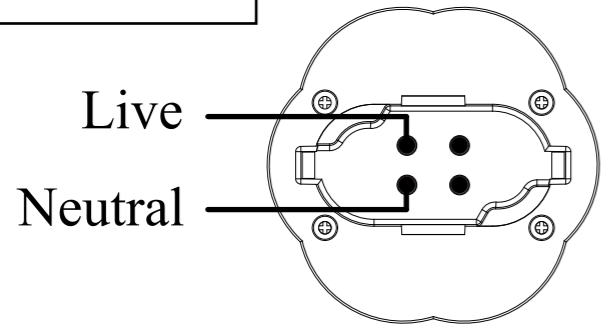

Installation: 3

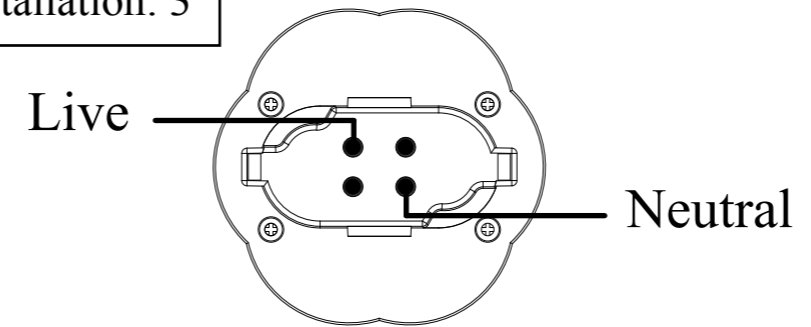

Installation: 5

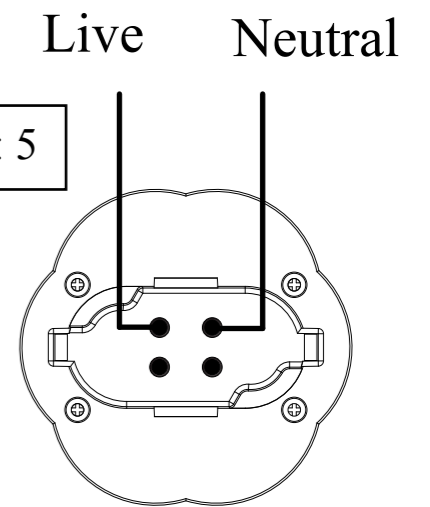

Installation: 2

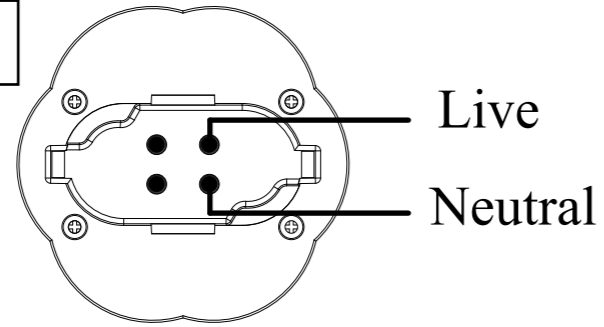

Installation: 4

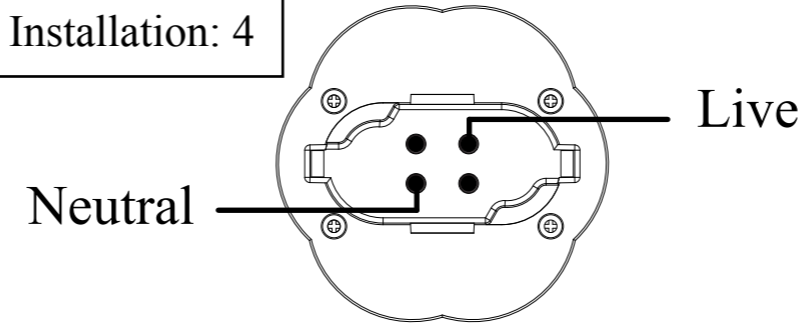

Installation: 6

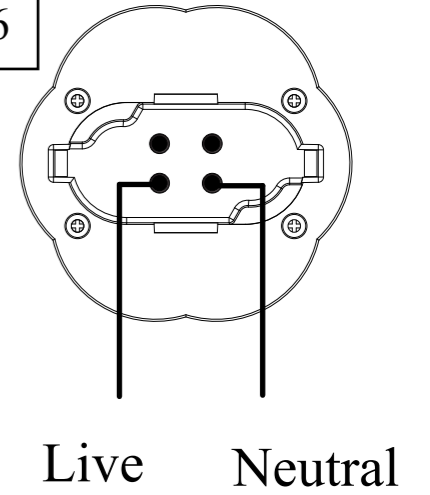

					SJ HIGHTECH CO.,LTD.					PROJECT NAME		
										FDL AC wire connection		
SYM	REVISION	DATE	SIGN	SCALE	1/1	DRAWN	DESIGN	CHECK	APPR	TITLE	FDL	DWG SIZE
				UNIT	mm	nao 2013.12.17			DRAWING NO.		ver 2	